

ADJUSTABLE BATTERY-BACKUP SUPERVISOR FOR RAM RETENTION

FEATURES

- Supply Current of 40 μA (Max)
- Battery Supply Current of 100 nA (Max)
- Supply Voltage Supervision Range:
 - Adjustable
 - Other Versions Available on Request
- Backup-Battery Voltage Can Exceed V_{DD}
- Power-On Reset Generator With Fixed 100-ms Reset Delay Time
- Active-High and Active-Low Reset Output
- Chip-Enable Gating: 3 ns (at $V_{DD} = 5\text{ V}$) Max Propagation Delay
- 10-Pin MSOP Package
- Temperature Range: -40°C to 85°C

APPLICATIONS

- Fax Machines
- Set-Top Boxes
- Advanced Voice Mail Systems
- Portable Battery-Powered Equipment
- Computer Equipment
- Advanced Modems
- Automotive Systems
- Portable Long-Time Monitoring Equipment
- Point-of-Sale Equipment

DESCRIPTION

The TPS3613-01 supervisory circuit monitors and controls processor activity by providing backup-battery switchover for data retention of CMOS RAM.

During power-on, reset (RESET and $\overline{\text{RESET}}$) is asserted when the supply voltage (V_{DD} or V_{BAT}) becomes higher than 1.1 V.

Thereafter, the supply voltage supervisor monitors V_{DD} at the SENSE pin through external feedback resistors and keeps reset active as long as SENSE remains below the threshold voltage, V_{IT} .

An internal timer delays the release of the reset state to ensure proper system reset. The delay time starts after SENSE rises above the threshold voltage, V_{IT} .

When SENSE drops below V_{IT} , reset becomes active again.

The TPS3613-01 is available in a 10-pin MSOP package and is characterized for operation over a temperature range of -40°C to $+85^{\circ}\text{C}$.

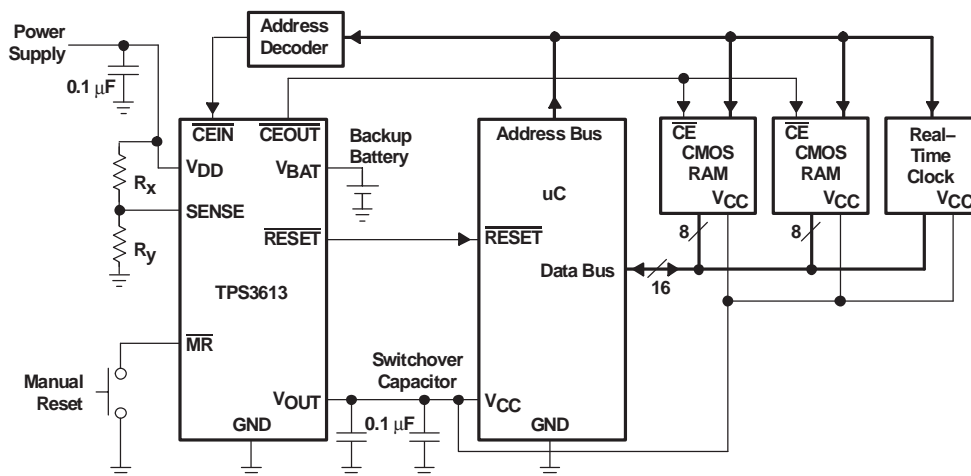

Please be aware that an important notice concerning availability, standard warranty, and use in critical applications of Texas Instruments semiconductor products and disclaimers thereto appears at the end of this data sheet.

All trademarks are the property of their respective owners.

PACKAGE INFORMATION

T _A	DEVICE NAME	MARKING
-40°C to +85°C	TPS3613-01DGSR†	AFK

† The DGSR passive indicates tape and reel of 2500 parts.

ordering information application specific versions

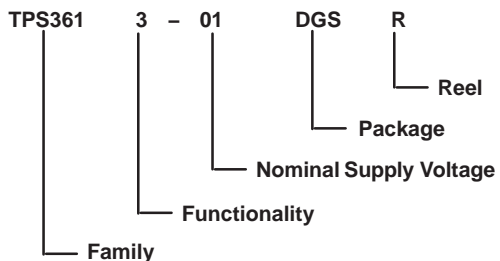

DEVICE NAME	NOMINAL VOLTAGE‡, V _{NOM}
TPS3613-01 DGS	Adjustable

‡ For other threshold voltages, contact the local TI sales office for availability and lead-time.

FUNCTION TABLE

SENSE > V _{IT}	V _{DD} > V _{BAT}	\overline{MR}	\overline{CEIN}	V _{OUT}	\overline{RESET}	RESET	\overline{CEOUT}
0	0	0	0	V _{BAT}	0	1	DIS
0	0	0	1	V _{BAT}	0	1	DIS
0	0	1	0	V _{BAT}	0	1	DIS
0	0	1	1	V _{BAT}	0	1	DIS
0	1	0	0	V _{DD}	0	1	DIS
0	1	0	1	V _{DD}	0	1	DIS
0	1	1	0	V _{DD}	0	1	DIS
0	1	1	1	V _{DD}	0	1	DIS
1	0	0	0	V _{DD}	0	1	DIS
1	0	0	1	V _{DD}	0	1	DIS
1	0	1	0	V _{DD}	1	0	0
1	0	1	1	V _{DD}	1	0	1
1	1	0	0	V _{DD}	0	1	DIS
1	1	0	1	V _{DD}	0	1	DIS
1	1	1	0	V _{DD}	1	0	0
1	1	1	1	V _{DD}	1	0	1

FUNCTIONAL SCHEMATIC

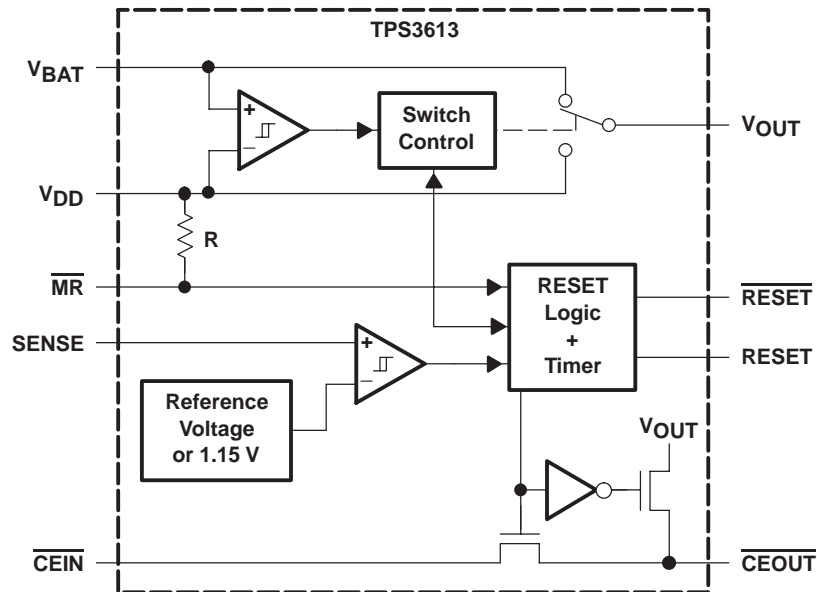

Terminal Functions

TERMINAL NAME	NO.	I/O	DESCRIPTION
$\overline{\text{CEIN}}$	5	I	Chip-enable input
$\overline{\text{CEOUT}}$	6	O	Chip-enable output
GND	3	I	Ground
$\overline{\text{MR}}$	4	I	Manual reset input
RESET	7	O	Active-high reset output
$\overline{\text{RESET}}$	9	O	Active-low reset output
SENSE	8	I	Adjustable sense input, assumed to be connect to V_{DD} throught feedback resistences. Call your local contacts for other application connections.
V_{BAT}	10	I	Backup-battery input
V_{DD}	2	I	Input supply voltage
V_{OUT}	1	O	Supply output

TIMING DIAGRAM

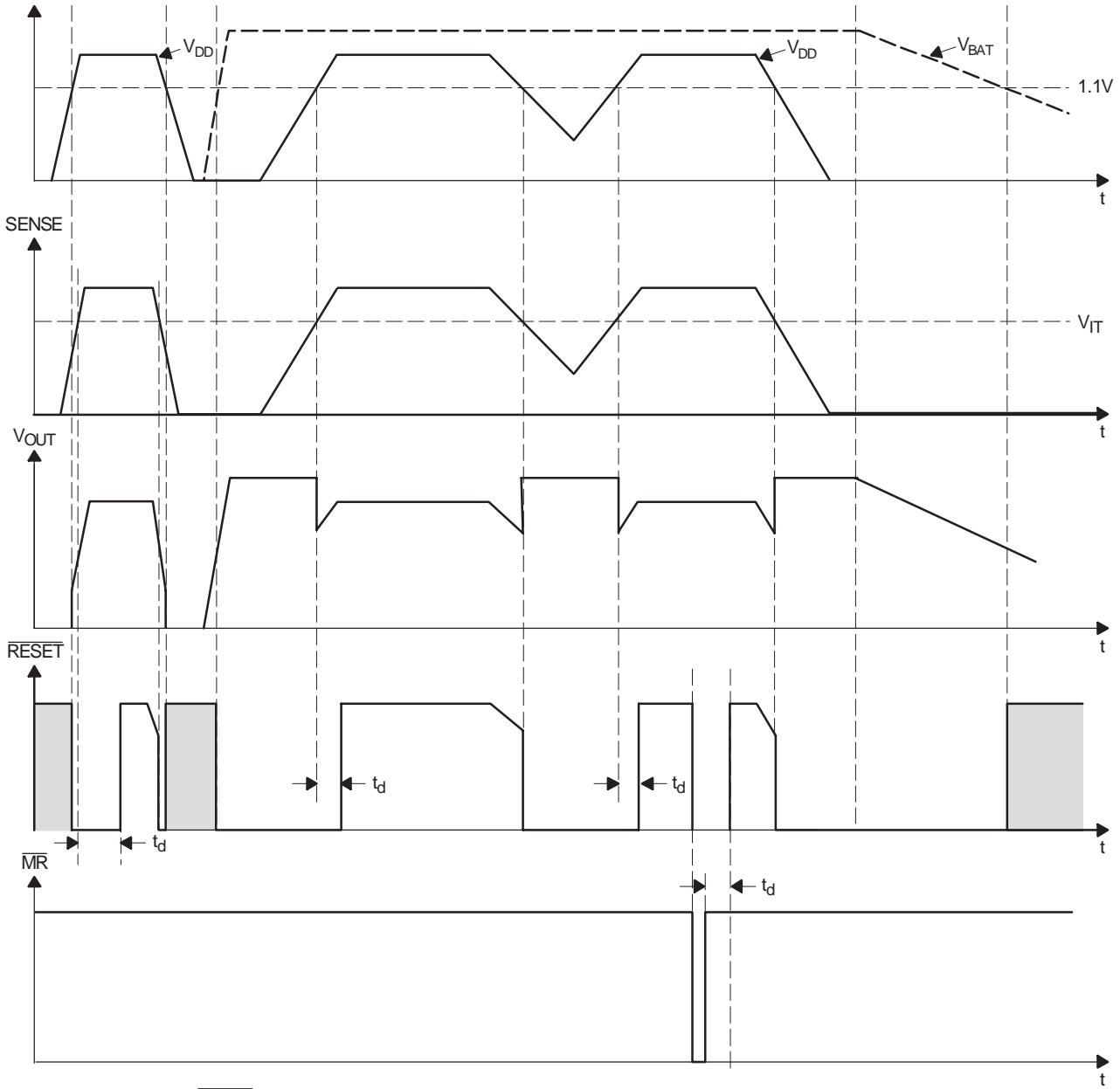

NOTE: Shaded area in $\overline{\text{RESET}}$ is *undefined*.

detailed description

backup-battery switchover

In case of a brownout or power failure, it may be necessary to preserve the contents of RAM. If a backup battery is installed at V_{BAT} , the device automatically switches the connected RAM to backup power when V_{DD} fails. In order to allow the backup battery (for example, 3.6-V lithium cells) to have a higher voltage than V_{DD} , these

supervisors do not connect V_{BAT} to V_{OUT} when V_{BAT} is greater than V_{DD} . V_{BAT} only connects to V_{OUT} (through a 15- Ω switch) when V_{DD} falls below V_{IT} and V_{BAT} is greater than V_{DD} . When V_{DD} recovers, switchover is deferred either until V_{DD} crosses V_{BAT} , or when V_{DD} rises above the reset threshold V_{IT} . V_{OUT} connects to V_{DD} through a 1- Ω (max) PMOS switch when V_{DD} crosses the reset threshold.

$V_{DD} > V_{BAT}$	$V_{DD} > V_{IT}$	V_{OUT}
1	1	V_{DD}
1	0	V_{DD}
0	1	V_{DD}
0	0	V_{BAT}

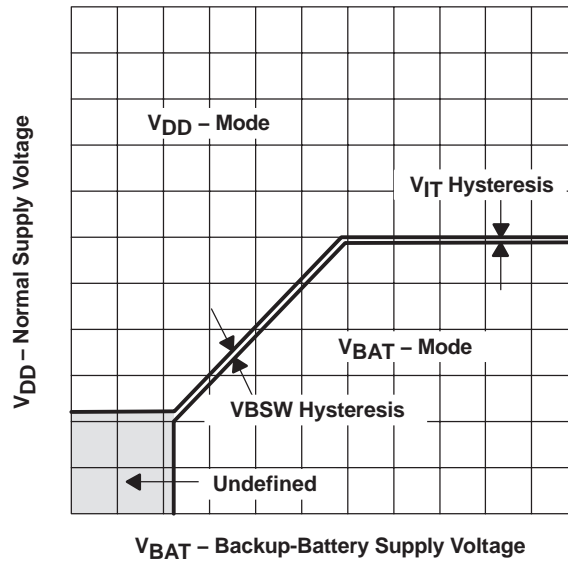

Figure 1. V_{DD} - V_{BAT} Switchover

detailed description (continued)

chip-enable signal gating

The internal gating of chip-enable (\overline{CE}) signals prevents erroneous data from corrupting CMOS RAM during an under-voltage condition. The TPS3613 uses a series transmission gate from \overline{CEIN} to \overline{CEOUT} . During normal operation (reset not asserted), the CE transmission gate is enabled and passes all CE transitions. When reset is asserted, this path becomes disabled, preventing erroneous data from corrupting the CMOS RAM. The short CE propagation delay from \overline{CEIN} to \overline{CEOUT} enables the TPS3613 device to be used with most processors.

The CE transmission gate is disabled and \overline{CEIN} is in high impedance (disable mode) while reset is asserted. During a power-down sequence when V_{DD} crosses the reset threshold, the CE transmission gate is disabled and \overline{CEIN} immediately becomes high impedance if the voltage at \overline{CEIN} is high. If \overline{CEIN} is low when reset

is asserted, the CE transmission gate is disabled when \overline{CEIN} goes high, or 15 μs after reset asserts, whichever occurs first. This allows the current write cycle to complete during power down. When the CE transmission gate is enabled, the impedance of \overline{CEIN} appears as a resistor in series with the load at \overline{CEOUT} . The overall device propagation delay through the CE transmission gate depends on V_{OUT} , the source impedance of the drive connected to \overline{CEIN} , and the load at \overline{CEOUT} . To achieve minimum propagation delay, the capacitive load at \overline{CEOUT} should be minimized, and a low-output-impedance driver is used.

In the disabled mode, the transmission gate is off and an active pullup connects \overline{CEOUT} to V_{OUT} . This pullup turns off when the transmission gate is enabled.

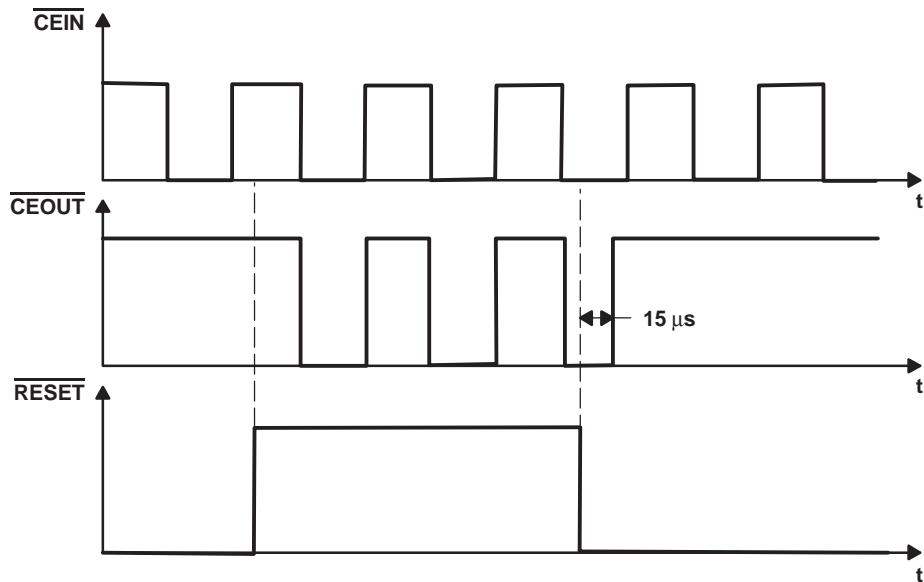

Figure 2. Chip-Enable Timing

ABSOLUTE MAXIMUM RATINGS

OVER OPERATING FREE-AIR TEMPERATURE (unless otherwise noted)⁽¹⁾

Supply voltage: V_{DD} ⁽²⁾	7 V
MR and SENSE pins ⁽²⁾	-0.3 V to ($V_{DD} + 0.3$ V)
Continuous output current at V_{OUT} : I_O	400 mA
All other pins, I_O	±10 mA
Continuous total power dissipation	See Dissipation Rating Table
Operating free-air temperature range, T_A	-40°C to +85°C
Storage temperature range, T_{stg}	-65°C to +150°C
Lead temperature soldering 1,6 mm (1/16 inch) from case for 10 seconds	+260°C

- (1) Stresses beyond those listed under absolute maximum ratings may cause permanent damage to the device. These are stress ratings only, and functional operation of the device at these or any other conditions beyond those indicated under recommended operating conditions is not implied. Exposure to absolute-maximum-rated conditions for extended periods may affect device reliability.
- (2) All voltage values are with respect to GND. For reliable operation the device must not operate at 7 V for more than t = 1000h continuously.

DISSIPATION RATING TABLE

PACKAGE	$T_A \leq +25^\circ\text{C}$ POWER RATING	DERATING FACTOR ABOVE $T_A = +25^\circ\text{C}$	$T_A = +70^\circ\text{C}$ POWER RATING	$T_A = +85^\circ\text{C}$ POWER RATING
DGS	424 mW	3.4 mW/°C	271 mW	220 mW

RECOMMENDED OPERATING CONDITIONS

	MIN	MAX	UNIT
Supply voltage, V_{DD}	1.65	5.5	V
Battery supply voltage, V_{BAT}	1.5	5.5	V
Input voltage, V_I	0	$V_{DD} + 0.3$	V
High-level input voltage, V_{IH}	$0.7 \times V_{DD}$		V
Low-level input voltage, V_{IL}	$0.3 \times V_{DD}$		V
Continuous output current at V_{OUT} , I_O	300		mA
Input transition rise and fall rate at MR, $\Delta t/\Delta V$	100		ns/V
Slew rate at V_{DD} or V_{bat}	1		V/ μ s
Operating free-air temperature range, T_A	-40	+85	°C

ELECTRICAL CHARACTERISTICS OVER RECOMMENDED OPERATING CONDITIONS (unless otherwise noted)

PARAMETER		TEST CONDITIONS	MIN	TYP	MAX	UNIT	
V _{OH}	High-level output voltage	$\overline{\text{RESET}}$	V _{DD} = 1.8 V, I _{OH} = -400 μA	V _{DD} - 0.2 V		V	
			V _{DD} = 3.3 V, I _{OH} = -2 mA V _{DD} = 5 V, I _{OH} = -3 mA	V _{DD} - 0.4 V			
		$\overline{\text{RESET}}$	V _{DD} = 1.8 V, I _{OH} = -20 μA	V _{DD} - 0.3 V			
			V _{DD} = 3.3 V, I _{OH} = -80 μA V _{DD} = 5 V, I _{OH} = -120 μA	V _{DD} - 0.4 V			
		$\overline{\text{CEOUT}}$	V _{OUT} = 1.8 V, I _{OH} = -1 mA	V _{OUT} - 0.2 V			
		Enable mode CEIN = V _{OUT}	V _{OUT} = 3.3 V, I _{OH} = -2 mA V _{OUT} = 5 V, I _{OH} = -5 mA	V _{OUT} - 0.3 V			
$\overline{\text{CEOUT}}$ Disable mode	V _{OUT} = 3.3 V, I _{OH} = -0.5 mA	V _{OUT} - 0.4 V					
V _{OL}	Low-level output voltage	$\overline{\text{RESET}}$	V _{DD} = 1.8 V, I _{OL} = 400 μA	0.2		V	
		$\overline{\text{RESET}}$	V _{DD} = 3.3 V, I _{OL} = 2 mA V _{DD} = 5 V, I _{OL} = 3 mA	0.4			
		$\overline{\text{CEOUT}}$	V _{OUT} = 1.8 V, I _{OL} = 1.0 mA	0.2			
		Enable mode CEIN = 0 V	V _{OUT} = 3.3 V, I _{OL} = 2 mA V _{OUT} = 5 V, I _{OL} = 5 mA	0.3			
		Power-up reset voltage (see Note 1)	V _{DD} > 1.1 V or V _{BAT} > 1.1 V, I _{OL} = 20 μA	0.4		V	
V _{OUT}	Normal mode	I _O = 8.5 mA, V _{DD} = 1.8 V, V _{BAT} = 0 V	V _{DD} - 50 mV		V		
		I _O = 125 mA, V _{DD} = 3.3 V, V _{BAT} = 0 V	V _{DD} - 150 mV				
		I _O = 200 mA, V _{DD} = 5 V, V _{BAT} = 0 V	V _{DD} - 200 mV				
	Battery-backup mode	I _O = 0.5 mA, V _{BAT} = 1.5 V, V _{DD} = 0 V	V _{BAT} - 20 mV				
		I _O = 7.5 mA, V _{BAT} = 3.3 V, V _{DD} = 0 V	V _{BAT} - 113 mV				
R _{DS(on)}	V _{DD} to V _{OUT} on-resistance	V _{DD} = 5 V	0.6	1	Ω		
	V _{BAT} to V _{OUT} on-resistance	V _{BAT} = 3.3 V	8	15			
V _{IT}	Negative-going input threshold voltage (see Note 2)		1.13	1.15	1.17	V	
V _{hys}	Hysteresis	Sense	1.1 V < V _{IT} < 1.65 V		12	mV	
		V _{BSW} (see Note 3)	V _{DD} = 1.8 V		55		
I _{IH}	High-level input current	$\overline{\text{MR}}$	MR = 0.7 × V _{DD} , V _{DD} = 5 V		-33	-76	μA
I _{IL}	Low-level input current	$\overline{\text{MR}}$	MR = 0 V, V _{DD} = 5 V		-110	-255	
I _I	Input current	SENSE	V _{DD} = 1.15 V		-25	25	nA
I _{DD}	V _{DD} supply current		V _{OUT} = V _{DD}		40	μA	
			V _{OUT} = V _{BAT}		40		
I _{BAT}	V _{BAT} supply current		V _{OUT} = V _{DD}		-0.1	0.1	μA
			V _{OUT} = V _{BAT}			0.5	
I _{Ikg}	$\overline{\text{CEIN}}$ leakage current	Disable mode, V _I < V _{DD}			±1		μA
C _i	Input capacitance	V _I = 0 V to 5 V			5		pF

(1) The lowest voltage at which $\overline{\text{RESET}}$ becomes active. $t_r(V_{DD}) \geq 15 \mu\text{s/V}$.

(2) To ensure best stability of the threshold voltage, a bypass capacitor (ceramic, 0.1 μF) should be placed near to the supply terminals.

(3) For V_{DD} < 1.6 V, V_{OUT} switches to V_{BAT} regardless of V_{BAT}.

TIMING REQUIREMENTS AT $R_L = 1\text{ M}\Omega$, $C_L = 50\text{ PF}$, $T_A = -40^\circ\text{C TO } +85^\circ\text{C}$

PARAMETER		TEST CONDITIONS	MIN	TYP	MAX	UNIT
t_w	Pulse width	SENSE	$V_{IH} = V_{IT} + 0.2\text{ V}$, $V_{IL} = V_{IT} - 0.2\text{ V}$		6	μs

SWITCHING CHARACTERISTICS AT $R_L = 1\text{ M}\Omega$, $C_L = 50\text{ PF}$, $T_A = -40^\circ\text{C TO } +85^\circ\text{C}$

PARAMETER		TEST CONDITIONS	MIN	TYP	MAX	UNIT	
t_d	Delay time	$V_{SENSE} \geq V_{IT} + 0.2\text{ V}$, $MR \geq 0.7 \times V_{DD}$, See timing diagram	60	100	140	ms	
t_{PLH}	Propagation (delay) time, low-to-high-level output	50% $\overline{\text{RESET}}$ to 50% $\overline{\text{CEOUT}}$	$V_{OUT} = V_{IT}$		15	μs	
t_{PHL}	Propagation (delay) time, high-to-low-level output	50% $\overline{\text{CEIN}}$ to 50% $\overline{\text{CEOUT}}$, $C_L = 50\text{ pF}$ only (see Note 5)	$V_{DD} = 1.8\text{ V}$		5	15	ns
			$V_{DD} = 3.3\text{ V}$		1.6	5	
			$V_{DD} = 5\text{ V}$		1	3	
		$\overline{\text{SENSE}}$ to $\overline{\text{RESET}}$		$V_{IL} = V_{IT} - 0.2\text{ V}$, $V_{IH} = V_{IT} + 0.2\text{ V}$		2	5
$\overline{\text{MR}}$ to $\overline{\text{RESET}}$		$V_{SENSE} \geq V_{IT} + 0.2\text{ V}$, $V_{IL} = 0.3 \times V_{DD}$, $V_{IH} = 0.7 \times V_{DD}$		0.1	1	μs	
Transition time		V_{DD} to V_{BAT}	$V_{IH} = V_{BAT} + 0.2\text{ V}$, $V_{IL} = V_{BAT} - 0.2\text{ V}$, $V_{BAT} < V_{IT}$		3		μs

(1) Assured by design

TYPICAL CHARACTERISTICS

Table of Graphs

			FIGURE
$r_{DS(on)}$	Static drain-source on-state resistance (V_{DD} to V_{OUT})	vs Output current	3
	Static drain-source on-state resistance (V_{BAT} to V_{OUT})	vs Output current	4
	Static drain-source on-state resistance (\overline{CEIN} to \overline{CEOUT})	vs Input voltage at \overline{CEIN}	5
I_{DD}	Supply current	vs Supply voltage	6
V_{IT}	Input threshold voltage at \overline{RESET}	vs Free-air temperature	7
V_{OH}	High-level output voltage at \overline{RESET}	vs High-level output current	8, 9
	High-level output voltage at \overline{CEOUT}		10, 11, 12, 13
V_{OL}	Low-level output voltage at \overline{RESET}	vs Low-level output current	14, 15
	Low-level output voltage at \overline{CEOUT}	vs Low-level output current	16, 17

STATIC DRAIN-SOURCE ON-STATE RESISTANCE (V_{DD} to V_{OUT}) vs OUTPUT CURRENT

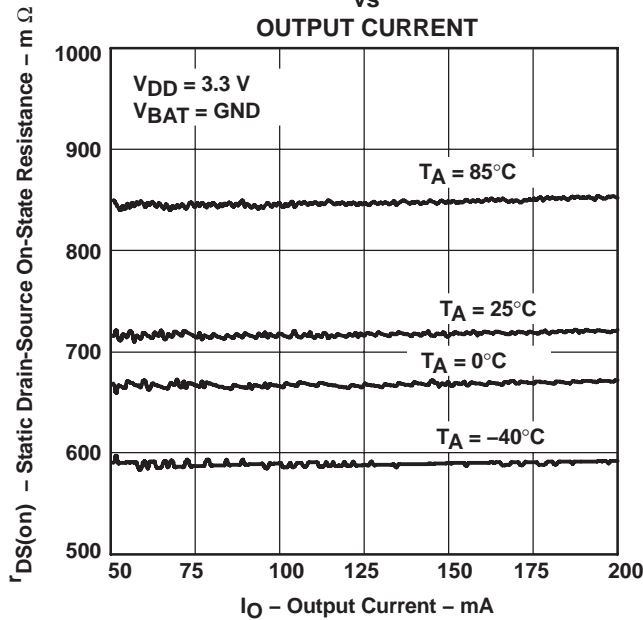

Figure 3

STATIC DRAIN-SOURCE ON-STATE RESISTANCE (V_{BAT} to V_{OUT}) vs OUTPUT CURRENT

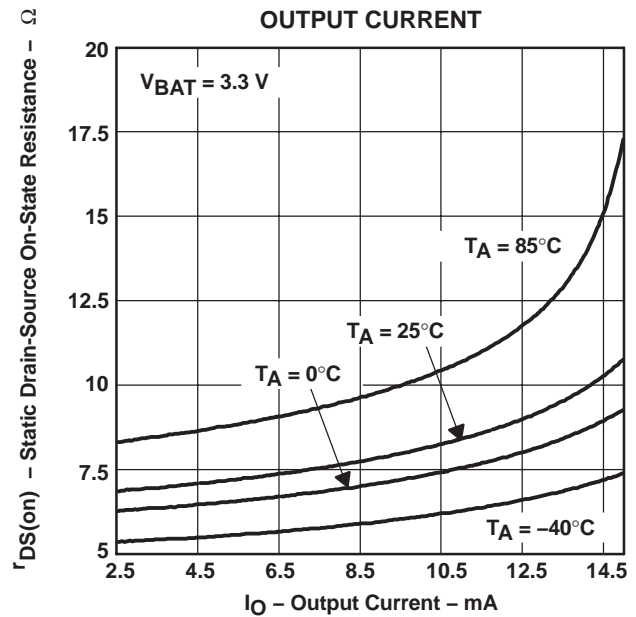

Figure 4

TYPICAL CHARACTERISTICS

**STATIC DRAIN-SOURCE ON-STATE RESISTANCE
(\overline{CEIN} to \overline{CEOUT})**

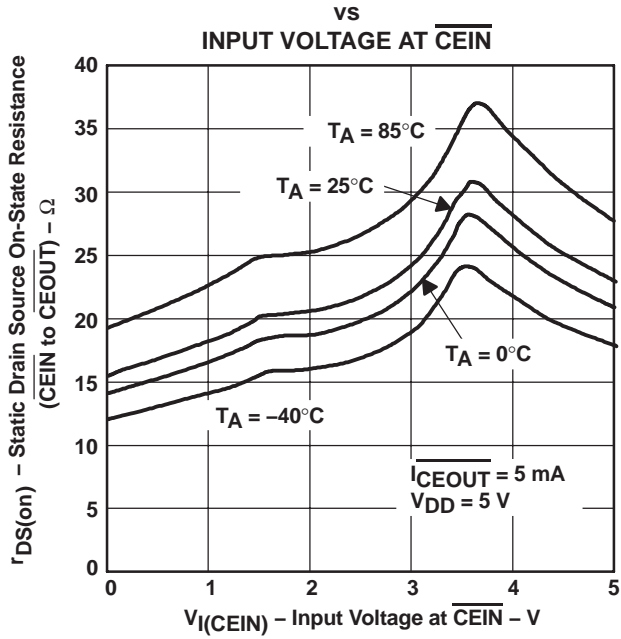

Figure 5

**SUPPLY CURRENT
vs
SUPPLY VOLTAGE**

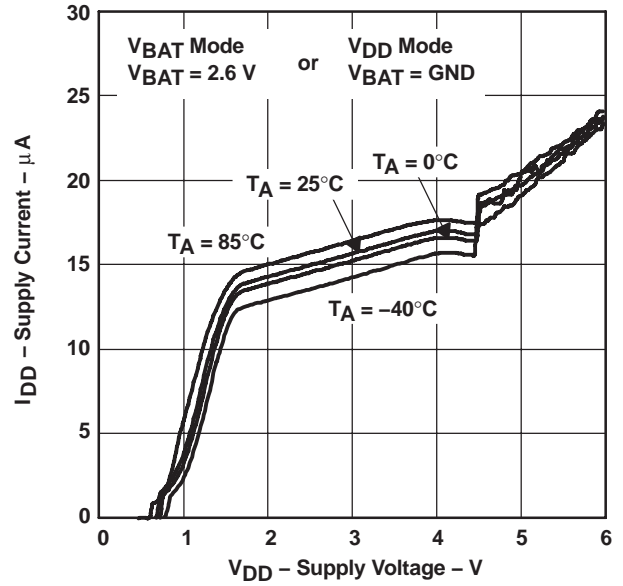

Figure 6

**INPUT THRESHOLD VOLTAGE AT \overline{RESET}
vs
FREE-AIR TEMPERATURE**

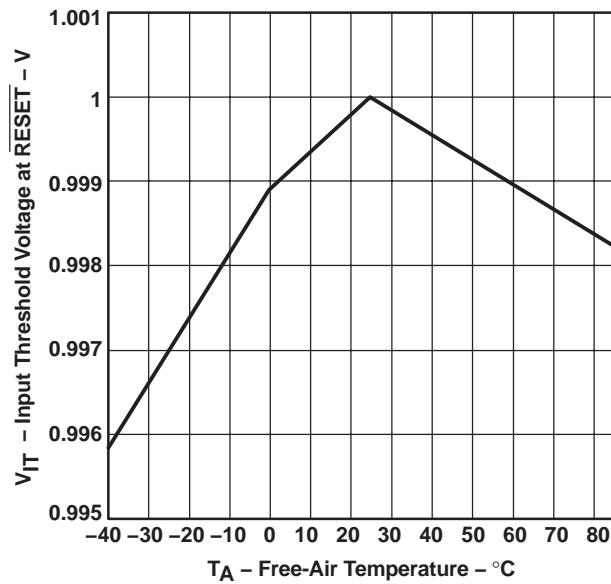

Figure 7

TYPICAL CHARACTERISTICS

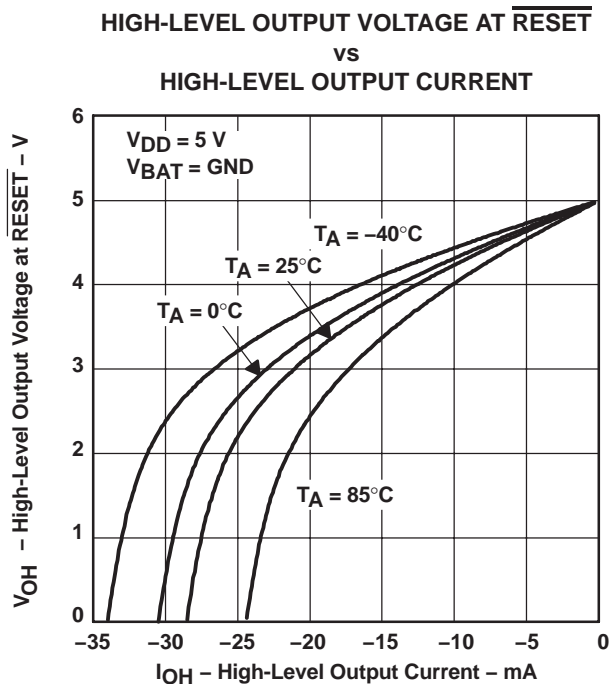

Figure 8

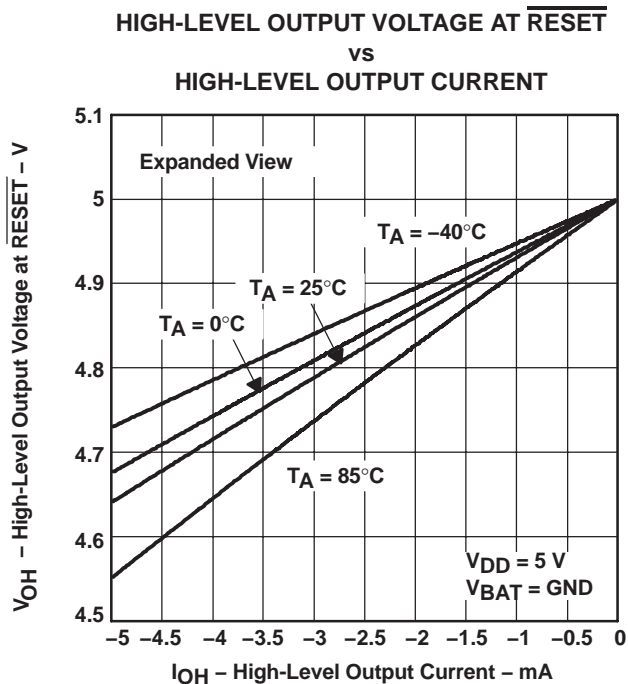

Figure 9

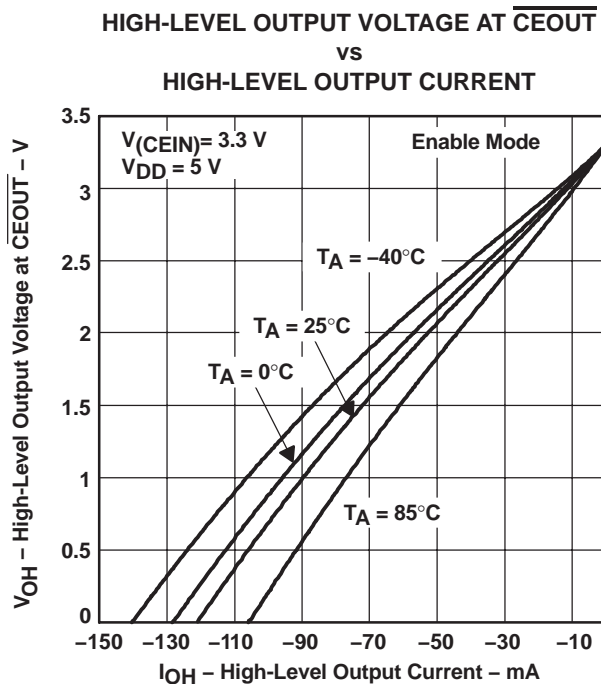

Figure 10

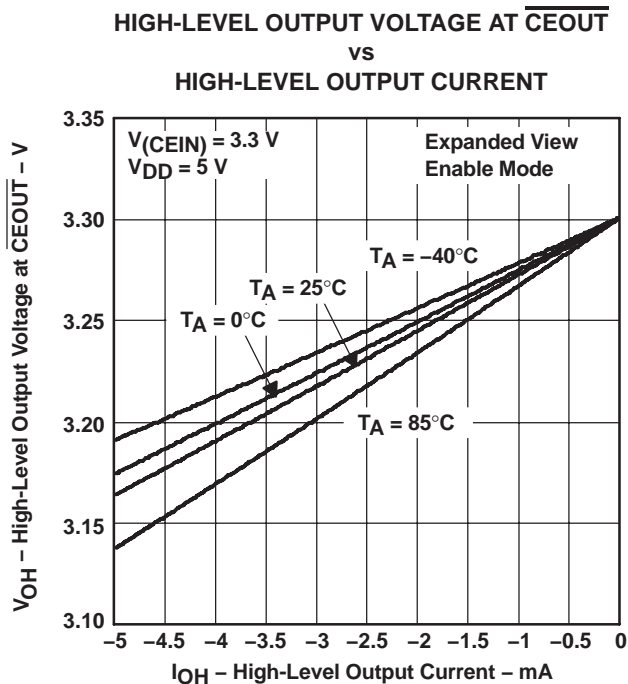
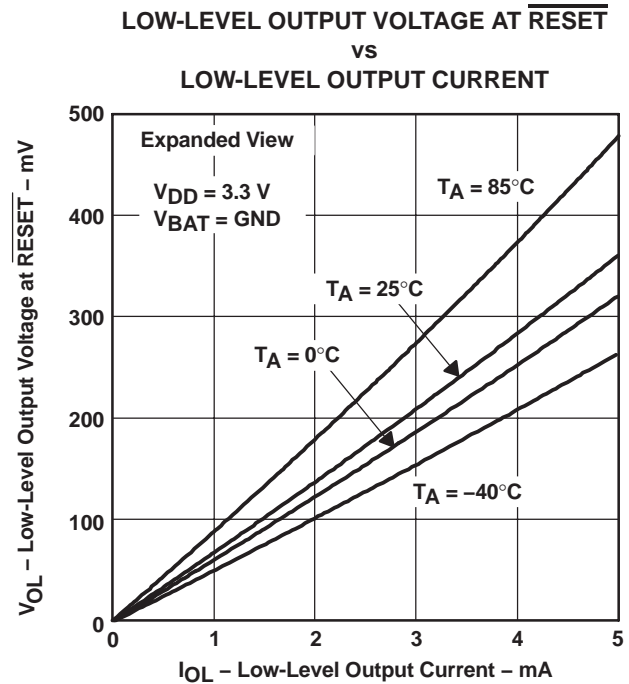
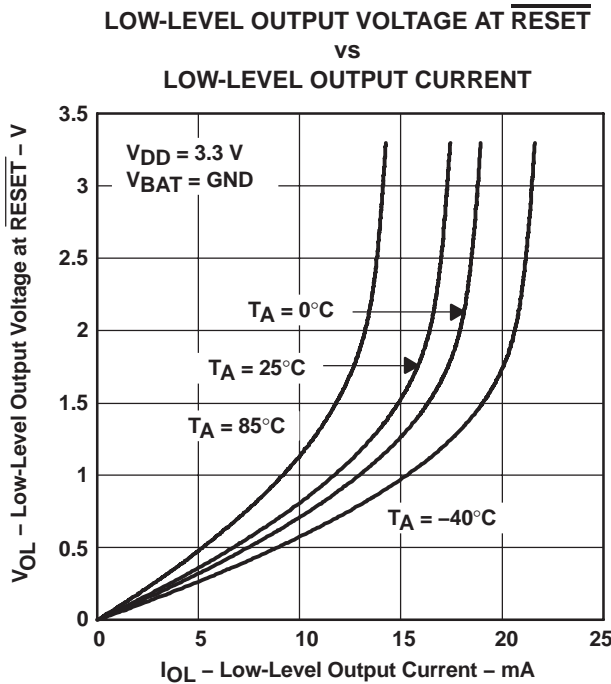
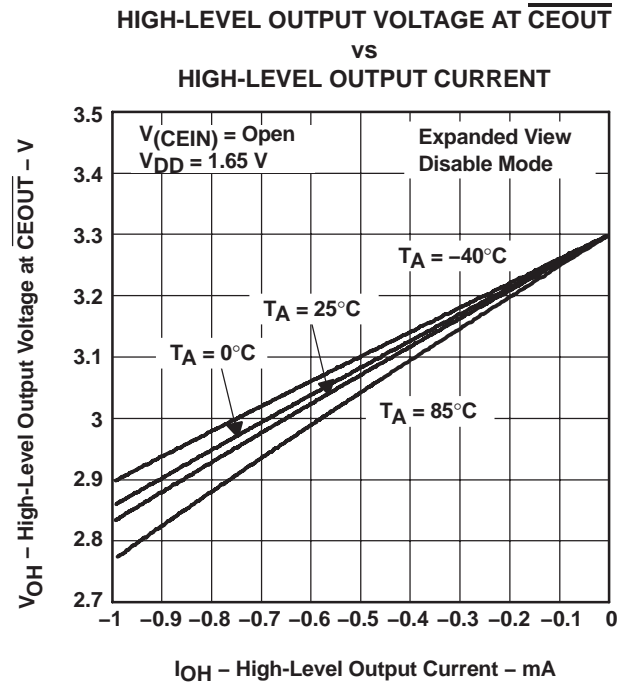
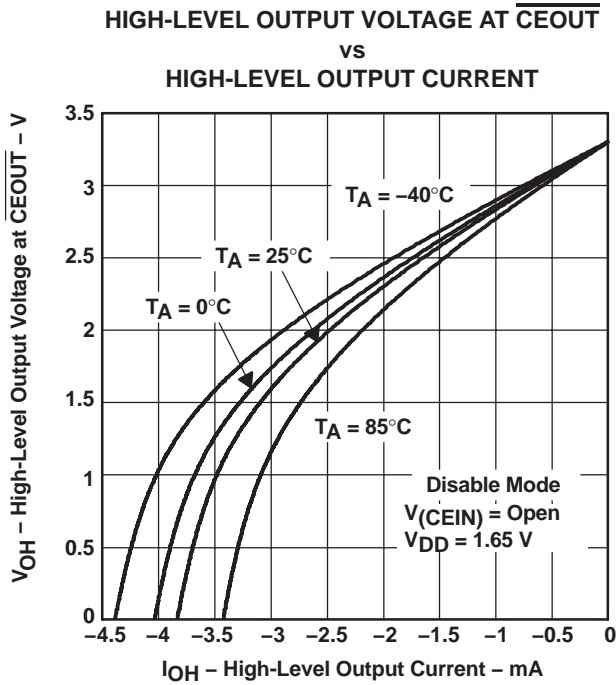

Figure 11

TYPICAL CHARACTERISTICS



TYPICAL CHARACTERISTICS

LOW-LEVEL OUTPUT VOLTAGE AT $\overline{\text{CEOUT}}$
vs
LOW-LEVEL OUTPUT CURRENT

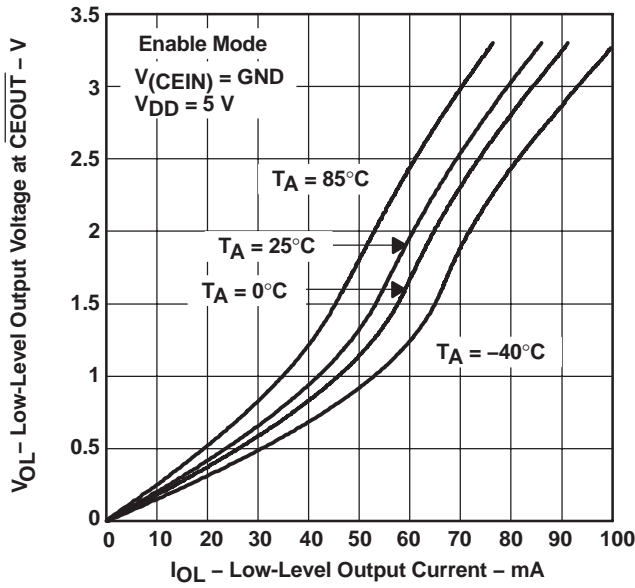

Figure 16

LOW-LEVEL OUTPUT VOLTAGE AT $\overline{\text{CEOUT}}$
vs
LOW-LEVEL OUTPUT CURRENT

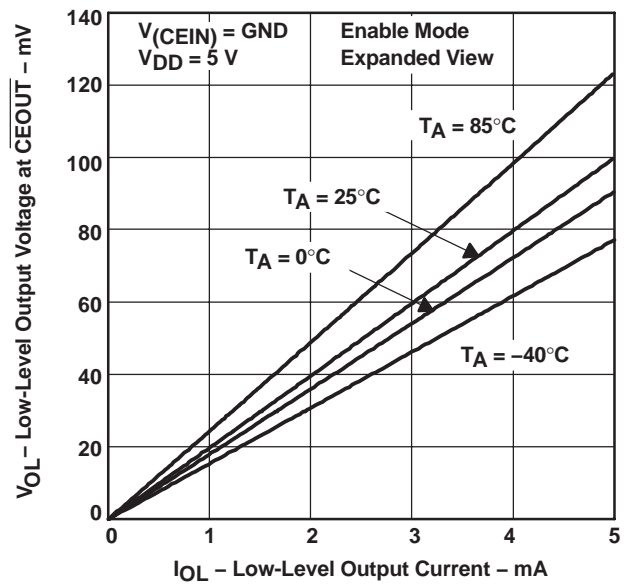

Figure 17

PACKAGING INFORMATION

Orderable Device	Status ⁽¹⁾	Package Type	Package Drawing	Pins	Package Qty	Eco Plan ⁽²⁾	Lead/Ball Finish	MSL Peak Temp ⁽³⁾
TPS3613-01DGS	ACTIVE	MSOP	DGS	10	80	Green (RoHS & no Sb/Br)	CU NIPDAU	Level-1-260C-UNLIM
TPS3613-01DGSG4	ACTIVE	MSOP	DGS	10	80	Green (RoHS & no Sb/Br)	CU NIPDAU	Level-1-260C-UNLIM
TPS3613-01DGSR	ACTIVE	MSOP	DGS	10	2500	Green (RoHS & no Sb/Br)	CU NIPDAU	Level-1-260C-UNLIM
TPS3613-01DGSRG4	ACTIVE	MSOP	DGS	10	2500	Green (RoHS & no Sb/Br)	CU NIPDAU	Level-1-260C-UNLIM

⁽¹⁾ The marketing status values are defined as follows:

ACTIVE: Product device recommended for new designs.

LIFEBUY: TI has announced that the device will be discontinued, and a lifetime-buy period is in effect.

NRND: Not recommended for new designs. Device is in production to support existing customers, but TI does not recommend using this part in a new design.

PREVIEW: Device has been announced but is not in production. Samples may or may not be available.

OBSOLETE: TI has discontinued the production of the device.

⁽²⁾ Eco Plan - The planned eco-friendly classification: Pb-Free (RoHS), Pb-Free (RoHS Exempt), or Green (RoHS & no Sb/Br) - please check <http://www.ti.com/productcontent> for the latest availability information and additional product content details.

TBD: The Pb-Free/Green conversion plan has not been defined.

Pb-Free (RoHS): TI's terms "Lead-Free" or "Pb-Free" mean semiconductor products that are compatible with the current RoHS requirements for all 6 substances, including the requirement that lead not exceed 0.1% by weight in homogeneous materials. Where designed to be soldered at high temperatures, TI Pb-Free products are suitable for use in specified lead-free processes.

Pb-Free (RoHS Exempt): This component has a RoHS exemption for either 1) lead-based flip-chip solder bumps used between the die and package, or 2) lead-based die adhesive used between the die and leadframe. The component is otherwise considered Pb-Free (RoHS compatible) as defined above.

Green (RoHS & no Sb/Br): TI defines "Green" to mean Pb-Free (RoHS compatible), and free of Bromine (Br) and Antimony (Sb) based flame retardants (Br or Sb do not exceed 0.1% by weight in homogeneous material)

⁽³⁾ MSL, Peak Temp. -- The Moisture Sensitivity Level rating according to the JEDEC industry standard classifications, and peak solder temperature.

Important Information and Disclaimer:The information provided on this page represents TI's knowledge and belief as of the date that it is provided. TI bases its knowledge and belief on information provided by third parties, and makes no representation or warranty as to the accuracy of such information. Efforts are underway to better integrate information from third parties. TI has taken and continues to take reasonable steps to provide representative and accurate information but may not have conducted destructive testing or chemical analysis on incoming materials and chemicals. TI and TI suppliers consider certain information to be proprietary, and thus CAS numbers and other limited information may not be available for release.

In no event shall TI's liability arising out of such information exceed the total purchase price of the TI part(s) at issue in this document sold by TI to Customer on an annual basis.

TAPE AND REEL INFORMATION



QUADRANT ASSIGNMENTS FOR PIN 1 ORIENTATION IN TAPE



*All dimensions are nominal

Device	Package Type	Package Drawing	Pins	SPQ	Reel Diameter (mm)	Reel Width W1 (mm)	A0 (mm)	B0 (mm)	K0 (mm)	P1 (mm)	W (mm)	Pin1 Quadrant
TPS3613-01DGSR	MSOP	DGS	10	2500	330.0	12.4	5.3	3.4	1.4	8.0	12.0	Q1

TAPE AND REEL BOX DIMENSIONS



*All dimensions are nominal

Device	Package Type	Package Drawing	Pins	SPQ	Length (mm)	Width (mm)	Height (mm)
TPS3613-01DGSR	MSOP	DGS	10	2500	358.0	335.0	35.0

DGS (S-PDSO-G10)

PLASTIC SMALL-OUTLINE PACKAGE

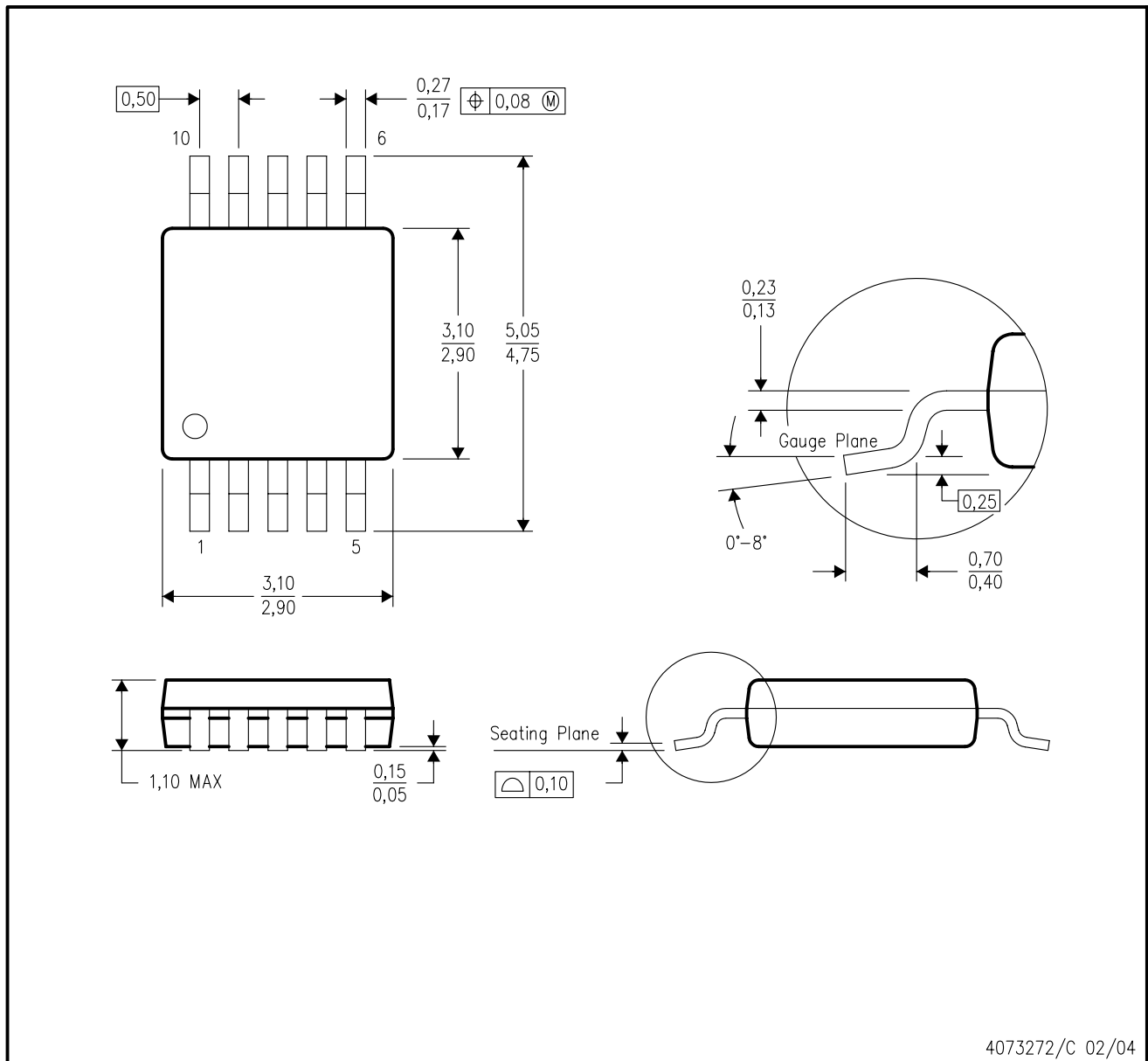

- NOTES:
- A. All linear dimensions are in millimeters.
 - B. This drawing is subject to change without notice.
 - C. Body dimensions do not include mold flash or protrusion.
 - D. Falls within JEDEC MO-187 variation BA.

IMPORTANT NOTICE

Texas Instruments Incorporated and its subsidiaries (TI) reserve the right to make corrections, modifications, enhancements, improvements, and other changes to its products and services at any time and to discontinue any product or service without notice. Customers should obtain the latest relevant information before placing orders and should verify that such information is current and complete. All products are sold subject to TI's terms and conditions of sale supplied at the time of order acknowledgment.

TI warrants performance of its hardware products to the specifications applicable at the time of sale in accordance with TI's standard warranty. Testing and other quality control techniques are used to the extent TI deems necessary to support this warranty. Except where mandated by government requirements, testing of all parameters of each product is not necessarily performed.

TI assumes no liability for applications assistance or customer product design. Customers are responsible for their products and applications using TI components. To minimize the risks associated with customer products and applications, customers should provide adequate design and operating safeguards.

TI does not warrant or represent that any license, either express or implied, is granted under any TI patent right, copyright, mask work right, or other TI intellectual property right relating to any combination, machine, or process in which TI products or services are used. Information published by TI regarding third-party products or services does not constitute a license from TI to use such products or services or a warranty or endorsement thereof. Use of such information may require a license from a third party under the patents or other intellectual property of the third party, or a license from TI under the patents or other intellectual property of TI.

Reproduction of TI information in TI data books or data sheets is permissible only if reproduction is without alteration and is accompanied by all associated warranties, conditions, limitations, and notices. Reproduction of this information with alteration is an unfair and deceptive business practice. TI is not responsible or liable for such altered documentation. Information of third parties may be subject to additional restrictions.

Resale of TI products or services with statements different from or beyond the parameters stated by TI for that product or service voids all express and any implied warranties for the associated TI product or service and is an unfair and deceptive business practice. TI is not responsible or liable for any such statements.

TI products are not authorized for use in safety-critical applications (such as life support) where a failure of the TI product would reasonably be expected to cause severe personal injury or death, unless officers of the parties have executed an agreement specifically governing such use. Buyers represent that they have all necessary expertise in the safety and regulatory ramifications of their applications, and acknowledge and agree that they are solely responsible for all legal, regulatory and safety-related requirements concerning their products and any use of TI products in such safety-critical applications, notwithstanding any applications-related information or support that may be provided by TI. Further, Buyers must fully indemnify TI and its representatives against any damages arising out of the use of TI products in such safety-critical applications.

TI products are neither designed nor intended for use in military/aerospace applications or environments unless the TI products are specifically designated by TI as military-grade or "enhanced plastic." Only products designated by TI as military-grade meet military specifications. Buyers acknowledge and agree that any such use of TI products which TI has not designated as military-grade is solely at the Buyer's risk, and that they are solely responsible for compliance with all legal and regulatory requirements in connection with such use.

TI products are neither designed nor intended for use in automotive applications or environments unless the specific TI products are designated by TI as compliant with ISO/TS 16949 requirements. Buyers acknowledge and agree that, if they use any non-designated products in automotive applications, TI will not be responsible for any failure to meet such requirements.

Following are URLs where you can obtain information on other Texas Instruments products and application solutions:

Products

Amplifiers	amplifier.ti.com
Data Converters	dataconverter.ti.com
DSP	dsp.ti.com
Clocks and Timers	www.ti.com/clocks
Interface	interface.ti.com
Logic	logic.ti.com
Power Mgmt	power.ti.com
Microcontrollers	microcontroller.ti.com
RFID	www.ti-rfid.com
RF/IF and ZigBee® Solutions	www.ti.com/lprf

Applications

Audio	www.ti.com/audio
Automotive	www.ti.com/automotive
Broadband	www.ti.com/broadband
Digital Control	www.ti.com/digitalcontrol
Medical	www.ti.com/medical
Military	www.ti.com/military
Optical Networking	www.ti.com/opticalnetwork
Security	www.ti.com/security
Telephony	www.ti.com/telephony
Video & Imaging	www.ti.com/video
Wireless	www.ti.com/wireless

Mailing Address: Texas Instruments, Post Office Box 655303, Dallas, Texas 75265
Copyright © 2008, Texas Instruments Incorporated